

# DECOSTRING SERIES

## DECOSTRING (DSW)



PROJECT

TYPE

NOTES

### ARCHITECTURAL FESTOON LIGHTING

#### DURABLE CONSTRUCTION

Built with high-quality components, including stainless steel aircraft cable for long runs and added strength, UV-rated wire for extended durability, UV-rated zip ties for secure fastening, and phenolic sockets designed to withstand harsh environments. Engineered to remain resilient and fully functional in extreme weather conditions.

#### VERSATILE APPLICATIONS

Decostrings are a specification-grade festoon lighting system engineered to endure harsh year-round conditions. Ideal for restaurants, hospitality venues, cityscape enhancements, and theme park installations, they offer both functional lighting and aesthetic appeal.

#### CUSTOMIZATION

Decostrings are custom-built to your specifications, offering precise run lengths and personalized lamp spacing. With a wide selection of lamps and decorative shades, you can tailor the lighting to match your vision. This level of customization brings your project ideas to life, ensuring both functionality and aesthetic appeal.

#### WET-RATED

Decostring system is ETL listed for permanent wet/damp/dry installations, ensuring durability in any environment. Proudly made in the USA.

MODEL	SPACING	LAMP	SHADE STYLE	SHADE FINISH	QTY / LENGTH	MOUNTING KITS
<b>DSW</b> WET / DAMP / DRY	<b>12</b> 12" O/C <b>18</b> 18" O/C <b>24</b> 24" O/C <b>36</b> 36" O/C <b>48</b> 48" O/C <b>60</b> 60" O/C CUSTOM (SPECIFY)	SELECT FROM LAMPS PAGE	<b>OPTIONAL</b> SELECT FROM SHADE PAGES	SELECT FROM SHADE PAGES	MUST PROVIDE QUANTITY AND LENGTH OF RUNS	<b>OPTIONAL</b> <b>SMK</b> STANDARD MOUNTING KIT (For drooped suspensions) <b>TMK</b> TURNBUCKLE MOUNTING KIT (For tensioned suspensions) <b>QL</b> QUICK LINK (For Intermediate points)
Refer to PG. 1,2	Refer to PG. 2	Refer to PG. 3	Refer to PG. 4, 5, 6, 7	Refer to PG. 6, 7	Refer to PG. 8	Refer to PG. 9



# DECOSTRING (DSW)

## SPECIFICATIONS

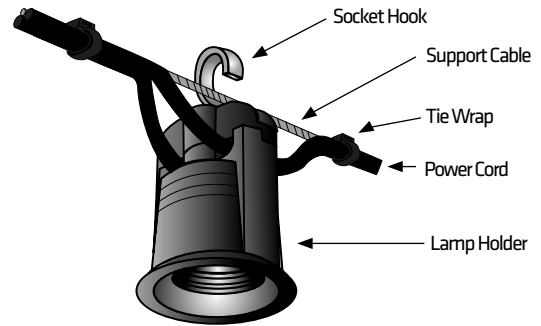
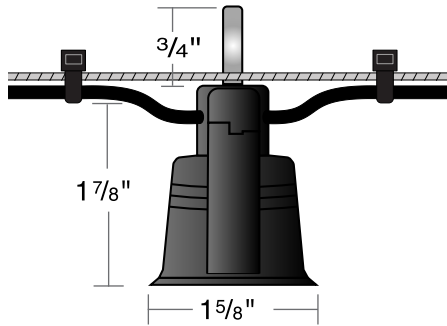

## SPECIFICATIONS

- VOLTAGE** 120 volts system. No drivers or transformers required.
- LAMP HOLDER** Black phenolic, medium base, UL weatherproof socket with hook for optional mounting
- POWER CORD** 12/2 AWG. Black flexible wire, UV rated for outdoor use
- SUPPORT CABLE** 3/32" 7X7 Stainless steel support aircraft cable, 920 lbs test / 175 lbs working load. Larger cable size available
- TIE WRAP** Heavy duty, black UV rated tie wraps secure power cable to support cable
- LAMPS** LED, 120V, medium base, dimmable, wet rated. Silicone coated available, refer to page 3 for details & options.
- SHADES** Optional, shapes made out of aluminum, steel and acrylic, refer to page 4,5,6,7 for details and options
- SPACING** Standard socket spacing: 12" O/C, 18" O/C, 24" O/C, 36" O/C, 48" O/C, 60" O/C. Custom spacing available
- MAXIMUM RUNS** Product is rated for 20A, 125V, 2500W, the maximum run we recommend per NEC is 16A, 1920W max.
- DIMMING** Dimmable to less than 10% with Primus lamps and ELV trailing edge type dimmers
- MOUNTING KITS** Heavy duty stainless steel mounting hardware available, refer to page 9 for details and options.
- PROTECTION KIT** (SGK) silicone grease kit for socket and lamp extra protection against corrosion and seizing. (Included)
- COLD TESTING** ETL cold weather tested to minus 40 degrees C, per IEC 60068-2-1 standards.
- PHOTOMETRY** ETL tested with bare & shielded lamp. BUG rating: B0-U0-G0 when using DSC7 (7" cone shade)
- WEIGHT/FT** The weight per foot includes: socket, power wire, support cable, tie wraps and lamp

12" O/C	18" O/C	24" O/C	36" O/C	48" O/C	60" O/C
0.24 lbs / ft	0.21 lbs / ft	0.20 lbs / ft	0.19 lbs / ft	0.17 lbs / ft	0.15 lbs / ft

- WARRANTY** Lamps - 3 year limited warranty, see [Warranty](#) for full terms.  
Decostring system - 5 year limited warranty, see [Warranty](#) for full terms.

## COMPLIANCE CERTIFICATIONS



# DECOSTRING (DSW)

## LAMPS



STANDARD LAMPS, 120V, MEDIUM BASE, WET RATED, OUTDOOR/INDOOR (INCLUDED)



G16.5

PART NO.	DESCRIPTION
G16.5/C/24/250	2.5W 24K, CLEAR
G16.5/W/24/250	2.5W 24K, WHITE
G16.5/C/27/350	3.0W 27K, CLEAR
G16.5/W/27/350	3.0W 27K, WHITE



A19

PART NO.	DESCRIPTION
A19/C/30/800	7.0W 30K, CLEAR
A19/W/30/800	7.0W 30K, WHITE
A19/A/22/360	4.5W 22K, AMBER



G25

PART NO.	DESCRIPTION
G25/C/27/500	4.5W 27K, CLEAR
G25/W/27/500	4.5W 27K, WHITE
G25/A/22/350	3.5W 22K, AMBER



G40

PART NO.	DESCRIPTION
G40/C/27/500	4.5W 27K, CLEAR
G40/W/27/500	4.5W 27K, WHITE
G40/A/22/360	4.5W 22K, AMBER



S14

PART NO.	DESCRIPTION
S14/C/24/140	1.5W 24K, CLEAR
S14/W/24/140	1.5W 24K, WHITE
S14/C/27/150	1.5W 27K, CLEAR
S14/W/27/150	1.5W 27K, WHITE
S14/R/100	1.0W, RED
S14/G/100	1.0W, GREEN
S14/B/100	1.0W, BLUE
S14/Y/100	1.0W, YELLOW



ST19

PART NO.	DESCRIPTION
ST19/A/22/360	4.5W 22K, AMBER



T10

PART NO.	DESCRIPTION
T10/C/27/350	3.5W 27K, CLEAR
T10/A/22/360	4.5W 22K, AMBER

The above lamps dim to off using ELV/TE trailing edge type dimmers.

\*Add "SC" at the end of the part number for silicone coated finish example: S14/C/24/150/SC

\*The actual finish color of the silicon-coated lamps may vary, resulting in the clear lamps having a frosted appearance.

# DECOSTRING (DSW)

## METAL SHADES



Decostring metal shades are hand crafted, aluminum or steel and feature powder coat finishes.

Most metal shades are shipped separately and easily installed in the field using our gasket ring to secure them to the socket.

All shades dimensions are nominal.

**Custom designs, sizes, and finishes are available, consult factory.**

### CONE

<b>C7</b>	(FINISH)	7" W X 3" H	0.38 lbs
<b>C10</b>	(FINISH)	10" W X 3" H	0.57 lbs
<b>C12</b>	(FINISH)	12" W X 4" H	1.13 lbs

Aluminum

Field Installed

Provides 0/0/0 BUG RATING



Shown: Dark Bronze

### HAT

<b>H4</b>	(FINISH)	4" W X 1 7/8" H	0.13 lbs
<b>H6</b>	(FINISH)	6" W X 2 1/4" H	0.25 lbs
<b>H8</b>	(FINISH)	8" W X 2 3/4" H	0.38 lbs

Aluminum

Factory Installed



Shown: Verde Bronze

### RADIAL WAVE

<b>RW4</b>	(FINISH)	4" W X 1 7/8" H	0.13 lbs
<b>RW6</b>	(FINISH)	6" W X 2 1/4" H	0.25 lbs
<b>RW8</b>	(FINISH)	8" W X 2 3/4" H	0.38 lbs

Aluminum

Factory Installed



Shown: Black

### PERFORATED TUBE

<b>PT4/6</b>	(FINISH)	4" W X 6" H	0.70 lbs
<b>PT6/8</b>	(FINISH)	6" W X 8" H	1.38 lbs

Aluminum

Field Installed



Shown: Custom Color

### PERFORATED TUBE WITH TOP DISC

<b>PTD</b>	(FINISH)	4" W X 8" H	1.13 lbs
------------	----------	-------------	----------

Aluminum

With 10" Top Disc

Field Installed

Consult factory for other sizes.



Shown: Dark Bronze

# DECOSTRING (DSW)

## METAL SHADES



### ATOM CAGE

**AC7** (FINISH) 7" Diameter 0.35 lbs  
Steel  
Factory Installed

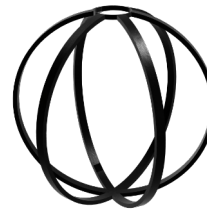

Shown: Black

### TUBE CAGE

**TC4/6** (FINISH) 4" W X 6" H 0.57 lbs  
**TC6/8** (FINISH) 6" W X 8" H 0.94 lbs  
Aluminum  
Field Installed



Shown: Dark Bronze

### ROUND CAGE

**RC** (FINISH) 8" W X 9" H 0.95 lbs  
Steel  
Field Installed



Shown: Custom Color

### SQUARE CAGE

**SC5/6** (FINISH) 5 1/2" W X 6 1/2" H 0.29 lbs  
**SC9/10** (FINISH) 9 1/2" W X 10 1/2" H 0.35 lbs  
Aluminum  
Field Installed

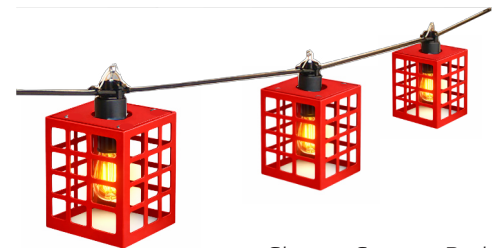

Shown: Custom Red

### OPEN WIRE GUARD

**OWG** (FINISH) 5 1/2" W X 7 1/2" H 0.39 lbs  
Steel  
Factory or field installed  
Yellow, silver and black are standard finishes

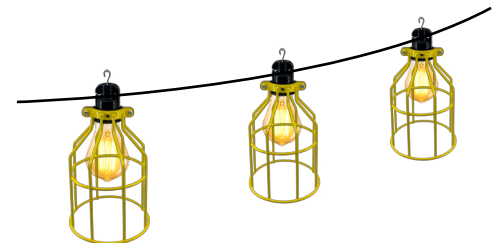

Shown: Yellow

### ENCLOSED WIRE GUARD

**EWG** (FINISH) 3 3/4" W X 5 1/2" H 0.16 lbs  
Steel  
Factory Installed  
Can be used with Cone and Dome shades.



Shown: Black

# DECOSTRING (DSW)

## METAL SHADES - FINISHES



### ROUND SHADE WITH GUARD

**RSG** (FINISH) 6" W X 5 1/8" H 0.57 lbs  
 Aluminum  
 Factory Installed  
 Delete "G" for no guard  
 Consult factory for other sizes



Shown: Custom Textured Bronze

### PERFORATED SPHERE

**PS6** (FINISH) 6" Diameter 0.48 lbs  
**PS8** (FINISH) 8" Diameter 0.70 lbs  
 Aluminum  
 Field Installed

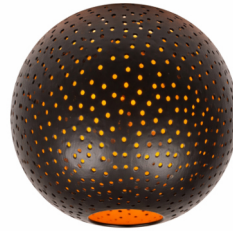

Shown: Black and Orange Interior

### DOME

**D7** (FINISH) 7" W X 3" H 0.48 lbs  
**D10** (FINISH) 10" W X 4.5" H 0.67 lbs  
 Aluminum  
 Field Installed  
 Provides 0/0/0 BUG RATING

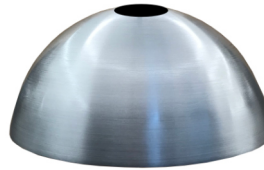

Shown: Custom

### METAL SHADES FINISHES

All finish options shown below are in powder coat.

Premium finishes are subject to additional cost.

The actual color of the product may vary from what is seen on electronic devices.

We cannot guarantee that the color you see on your screen accurately reflects the true color of the product.

#### S STANDARD FINISHES



**DB** - DARK BRONZE

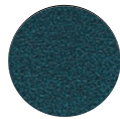

**VB** - VERDE BRONZE

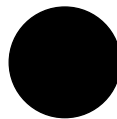

**B** - BLACK

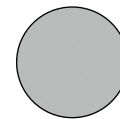

**S** - SATIN

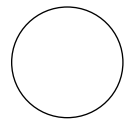

**W** - WHITE

#### P PREMIUM FINISHES



**BA** - BRUSHED ALUMINUM WITH CLEAR COAT



**BC** - BRASS WITH CLEAR COAT



**C** - CUSTOM COLOR POWDER COAT (Provide RAL#)

**RB** - RAW BRASS

# DECOSTRING (DSW)

## ACRYLIC SHADES - FINISHES



Decostring plastic shades are made out acrylic for indoor and outdoor use.

All plastic shades are shipped separately and easily attached in the field using our gasket ring to secure them to the socket.

All shades dimensions are nominal.

**Custom designs, sizes, and finishes are available, consult factory.**

### ACRYLIC SPHERE

<b>AS8</b>	(FINISH)	8" Diameter	0.57 lbs
<b>AS10</b>	(FINISH)	10" Diameter	1.00 lbs
<b>AS12</b>	(FINISH)	12" Diameter	1.34 lbs

Acrylic  
Field Installed  
All finish options available



Shown: White Acrylic

### ACRYLIC DOME

<b>AD8</b>	(FINISH)	8" W X 4" H	0.37 lbs
<b>AD10</b>	(FINISH)	10" W X 5" H	0.65 lbs
<b>AD12</b>	(FINISH)	12" W X 6" H	0.95 lbs

Acrylic  
Field Installed  
All finish options available



Shown: White Acrylic

### ACRYLIC TUBE

<b>AT3/5</b>	(FINISH)	3 3/4" W X 5 1/4" H	0.55 lbs
<b>AT4/7</b>	(FINISH)	4" W X 7" H	0.88 lbs

Acrylic  
Field Installed  
Standard finish options only



Shown: White Acrylic

### ACRYLIC SHADES FINISHES

**Premium finishes are subject to additional cost.**

The actual color of the product may vary from what is seen on electronic devices.

We cannot guarantee that the color you see on your screen accurately reflects the true color of the product.

#### **S** STANDARD FINISHES



**C** - CLEAR



**W** - WHITE

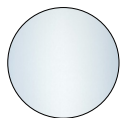

**F** - FROSTED

#### **P** PREMIUM FINISHES



**R** - RED



**B** - BLUE



**G** - GREEN

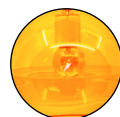

**Y** - YELLOW

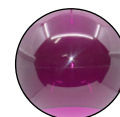

**P** - PURPLE



**O** - ORANGE

### RUN LENGTH DETAILS

**When ordering, must provide runs quantity and runs length.**

Decostrings are custom-ordered and built to specific run lengths and socket lamp spacing.

Each run length comes with a standard 4' power lead on one end, along with 4' support cable tails on both ends for suspension and adjustment, for both tensioned and drooping installations. See illustration below for more details.

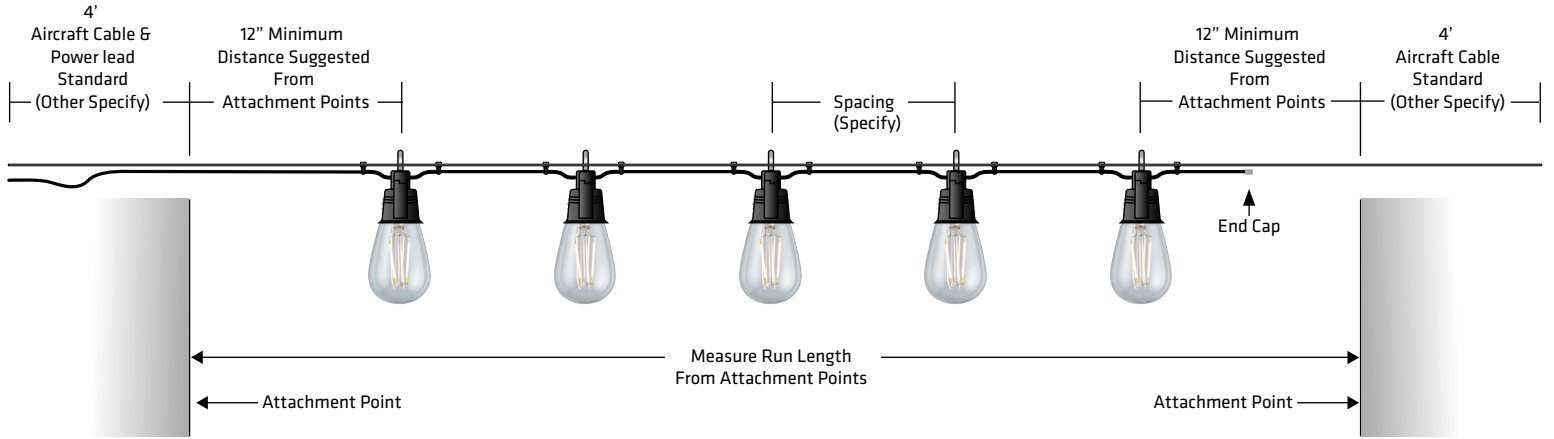

### TYPICAL RUN LAYOUTS (TOP VIEW)

The Illustrations below are examples of the most common run layouts.

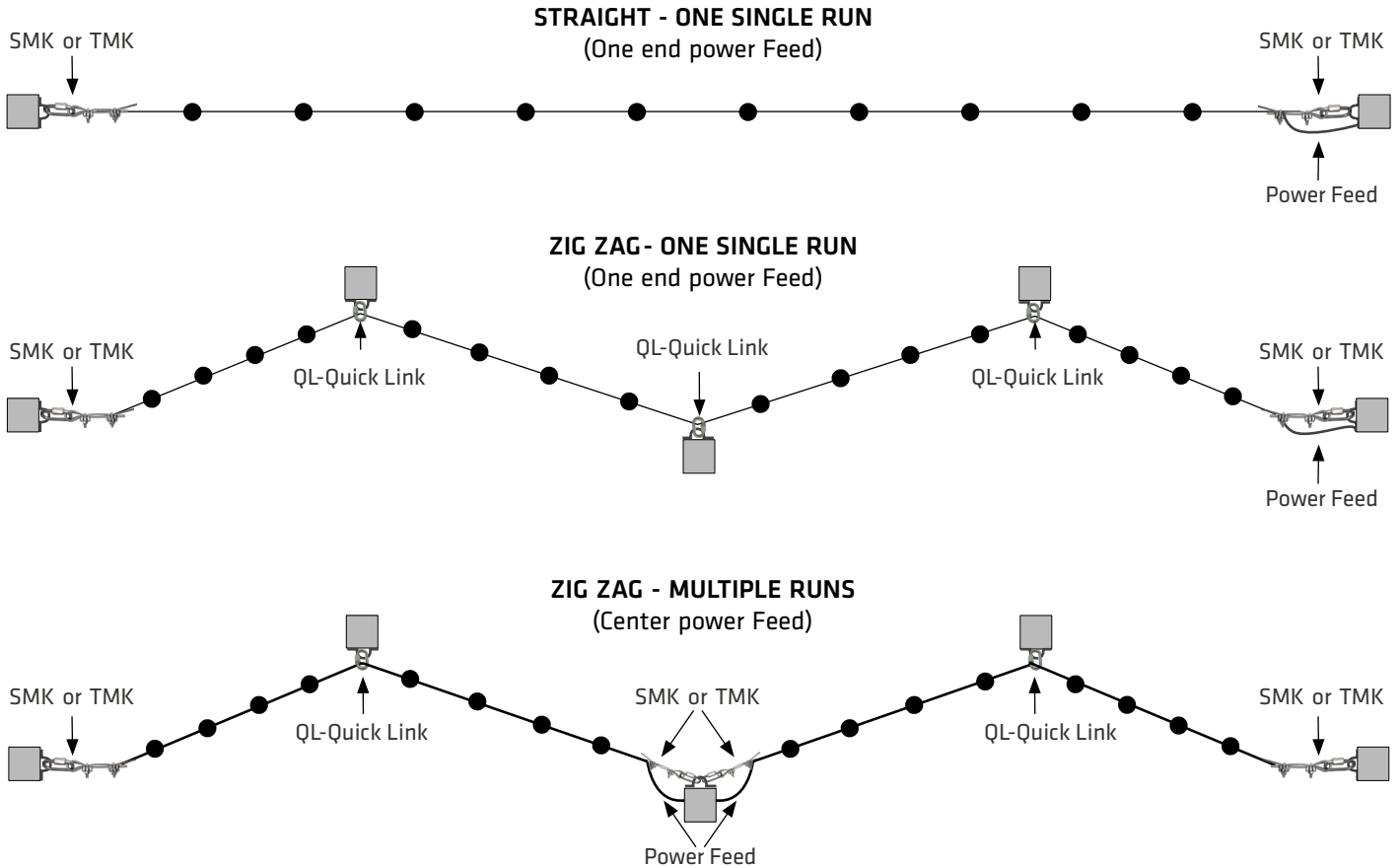

### (SMK) - STANDARD MOUNTING KIT (FOR DROOPED SUSPENSIONS)

Standard mounting kit includes stainless steel hardware for both ends of the run:

- (2) - 1/4" Quick links 5/16" gate opening
- (2) - 3/32" thimbles
- (4) - 3/32" Cable clamps



### (TMK) - TURNBUCKLE MOUNTING KIT (FOR TENSIONED SUSPENSIONS)

Turnbuckle mounting kit includes stainless steel hardware for both ends of the run:

- (2) - 1/4" Jaw style turnbuckles, 7/16" gate opening
- (2) - 3/32" Thimbles
- (6) - 3/32" Cable clamps



### (QL) - QUICK LINK (FOR INTERMEDIATE POINTS)

Quick link includes stainless steel hardware for intermediate points on continuous zig-zag or pattern runs:

- (1) - 1/4" Quick link 5/16" gate opening. Larger available.

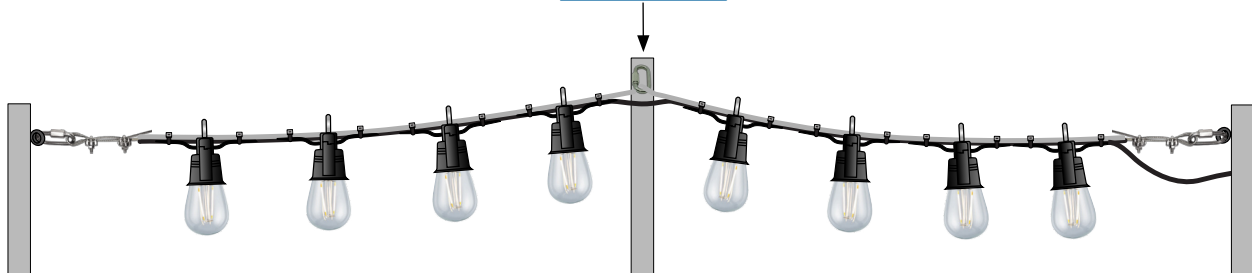

Decostrings are designed and listed for dry, damp, wet location and permanent installation. Electrical connections must be done by a qualified electrician and according to local and NEC requirements. Below are some options and details of customary installations. All electrical hardware required for the installation by others.

### HARDWIRE / WET LOCATION

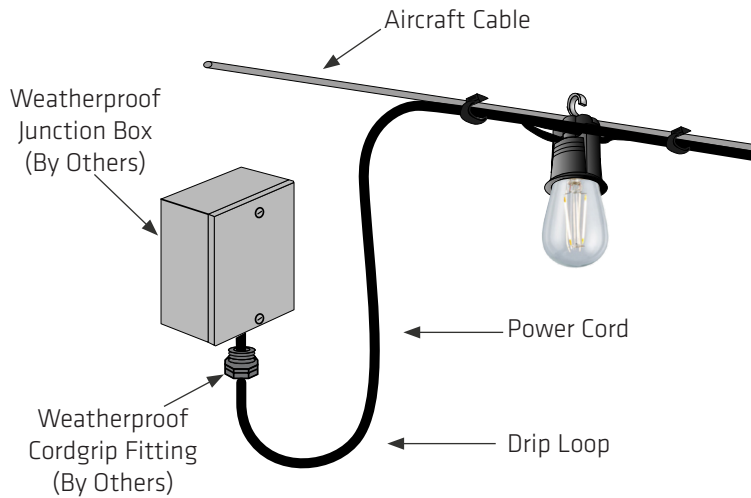

### HARDWIRE / DRY, DAMP LOCATION

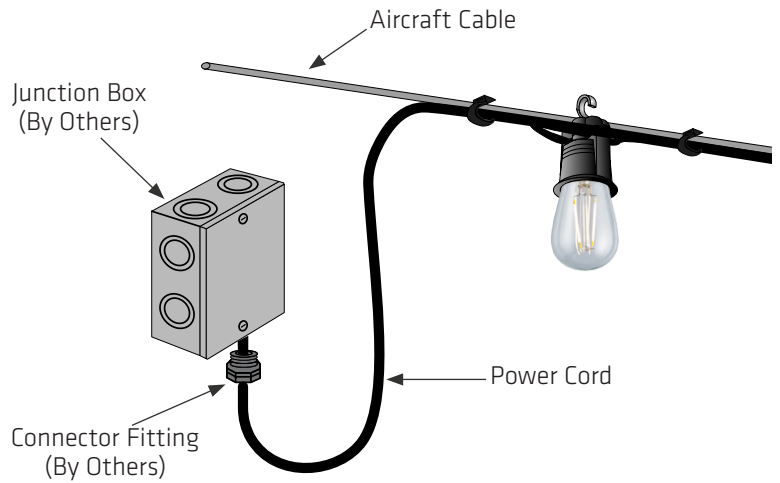

### POWER PLUG / DRY & WET LOCATION

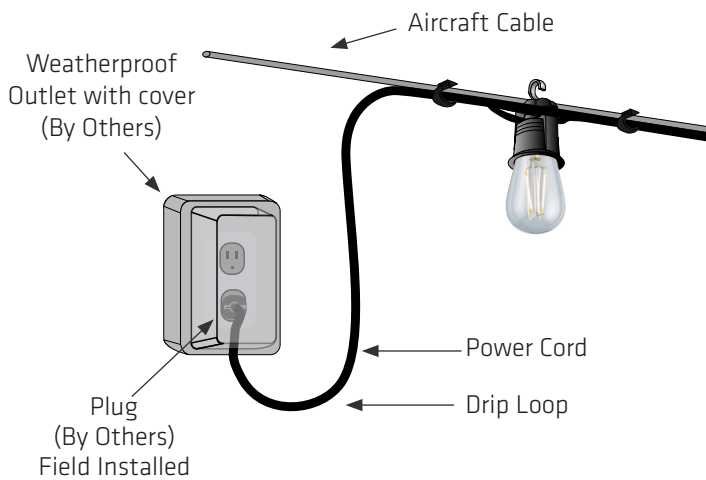

Power plug, must connect to a weatherproof outlet with cover. GFCI not recommended due to false tripping.

### POLE HARDWIRE / WET LOCATION

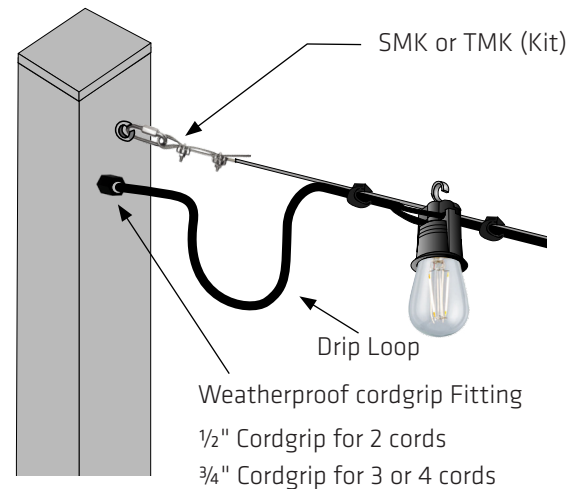

Pole connection can include a cord grip at the top /side of the pole with wiring connections protected under the pole cap.

### ( AFG ) - ABOVE FINISH GRADE (HEIGHT MINIMUM REQUIREMENTS)

See illustrations below for AFG-Above finish grade, NEC (225-18) minimum height requirements. Other local codes may have different height requirements.

**PEDESTRIAN**

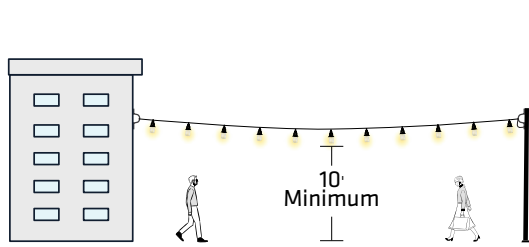

**VEHICULAR**

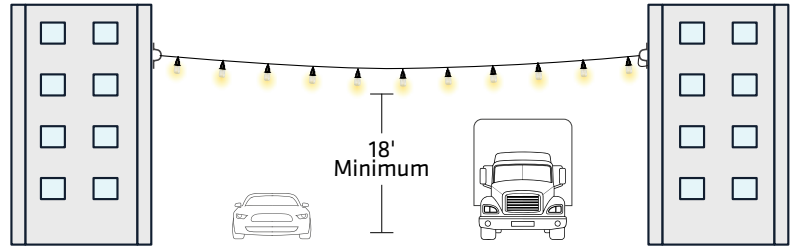

### VERSATILE APPLICATIONS

The illustrations below demonstrate just a few of the countless ways Decostrings can be used and applied.

**BUILDING TO BUILDING**



**POLE TO POLE**



**BUILDING TO POLE**



**CUSTOM**



**INDOORS**



**EXTREME COLD WEATHER**

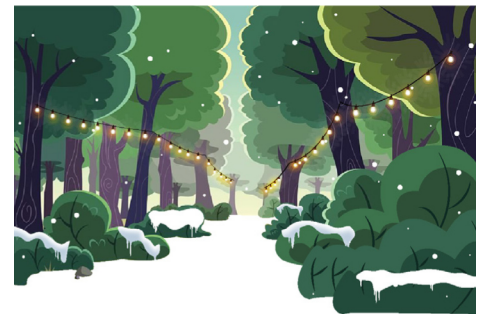

### BARE LAMP (S14/1.5W/27K/150L)

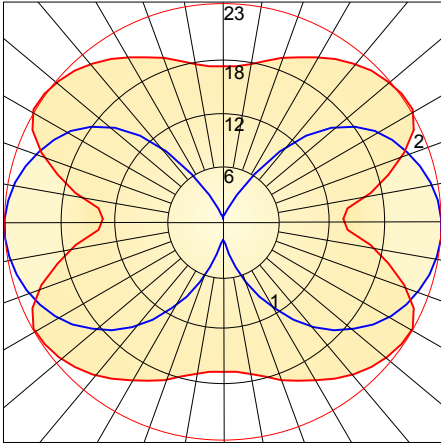

PHOTOMETRICS

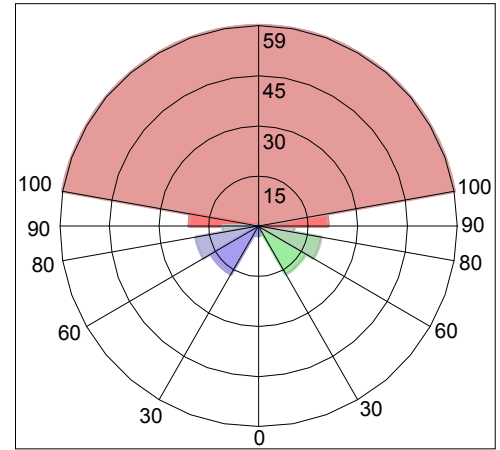

BUG RATING (B0-U3-G1)

Luminaire Lumens:  
 Front: Low=2.7, Medium=16.3, High=18.9, Very High=10.5  
 Back: Low=2.7, Medium=16.3, High=18.9, Very High=10.5  
 Uplight: Low=20.6, High=59.4

### LAMP WITH 7" CONE SHADE (S14/1.5W/27K/150L)

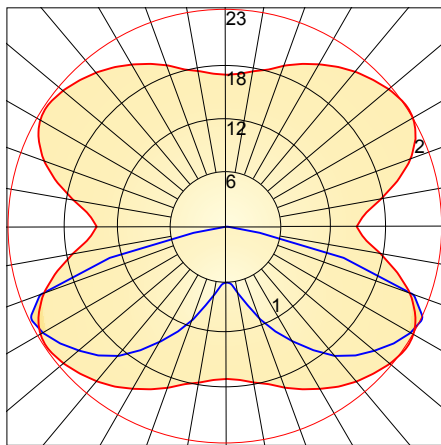

PHOTOMETRICS

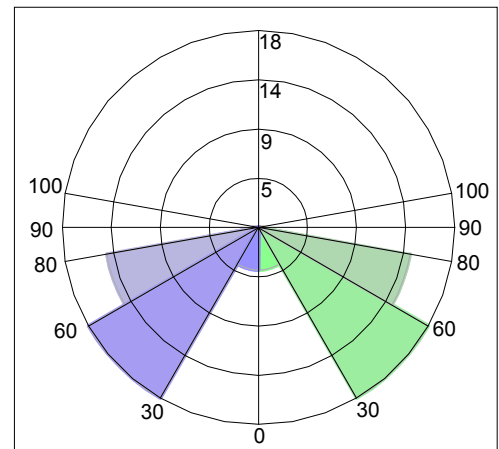

BUG RATING (B0-U0-G0)  
(Dark Sky Compliant)

Maximum Candela = 22.135 Located At Horizontal Angle = 30, Vertical Angle = 65  
 # 1 - Vertical Plane Through Horizontal Angles (30 - 210) (Through Max. Cd.)  
 # 2 - Horizontal Cone Through Vertical Angle (65) (Through Max. Cd.)

Luminaire Lumens:  
 Front: Low=3.9, Medium=18.2, High=14.3, Very High=0.5  
 Back: Low=3.9, Medium=18.2, High=14.3, Very High=0.5  
 Uplight:

#### LAMP CONVERSION CHART TO RATIO IES PHOTOMETRY

LAMP	WATTS	LUMENS MULTIPLIER
S14 27K	1.5	150
G16.5 27K	2.0	200
G16.5 27K	3.5	325
A15 27K	4.5	500
ST19 22K	3.5	300