

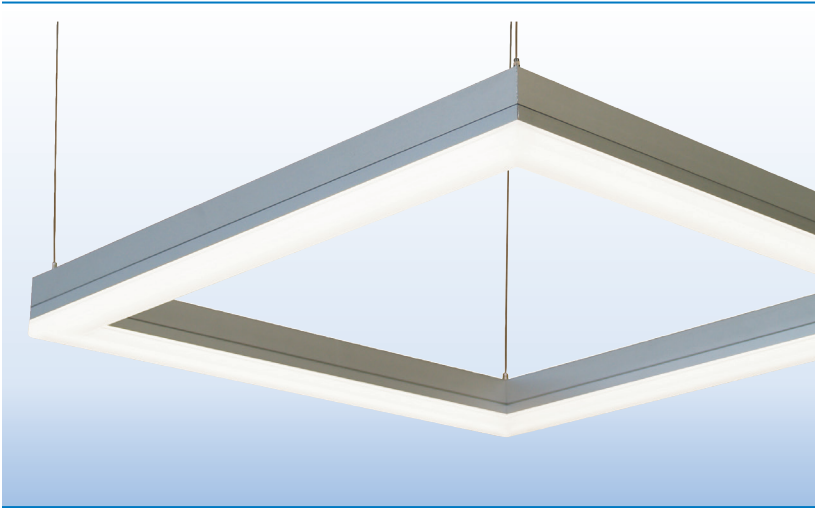

LED SQUARES / CABLE SUSPENDED / SURFACE MOUNT



PROJECT:
TYPE:

SPECIFICATIONS

DESCRIPTION	Architectural LED squares available with down light, up light, inside light or outside light options.
HOUSING	Extruded aluminum housing, 1 3/8" wide.
FINISH	Satin anodized or white paint finish standard. Custom finish optional.
LENS	Three styles, extruded acrylic, snap-on frosted widespread lens, smooth uniformity and no pixelization.
LED DRIVER	Integral or remote (<i>Included</i>), universal voltage; 0-10V dimming standard; custom programmable.
MOUNTING	Cable suspended and surface mount: See page 3 for details and options.
LED's	(LED boards) 50,000 hours. (L70), 80 CRI, 2700K, 3000K, 3500K and 4000K.
CERTIFICATION	ETL/CSA listed for damp locations.  2001431  MADE IN THE USA

OPTIONS

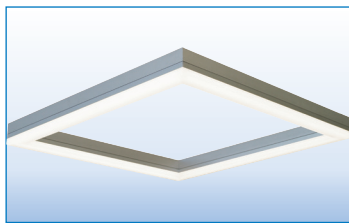

Q1 - DL - DOWN LIGHT

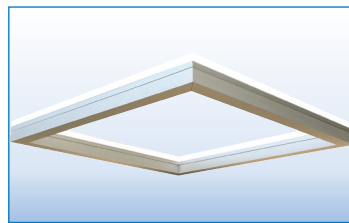

Q1 - UL - UP LIGHT

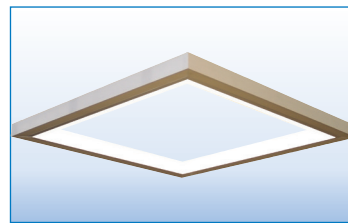

Q1 - IL - INSIDE LIGHT

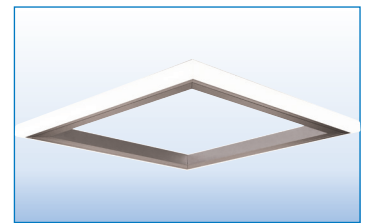

Q1 - OL - OUTSIDE LIGHT

PART NUMBER

SERIES	LUMENS	COLOR	LENS	VOLTS	DRIVER	MOUNTING	CABLE	FINISH	FIXTURE SIZE
Q1 - DL	L LOW	27K 2700K	SQL SQUARE	UNV	I INTEGRAL	SC STRAIGHT CABLE	36"	S SATIN	2' X 2'
Q1 - UL	M MEDIUM	3K 3000K	RLR ROUND	(120/277) 10% DIM	R REMOTE	PC PYRAMID CABLE	48"	W WHITE	3' X 3'
Q1 - IL	H HIGH	35K 3500K	FRL FLAT	UNV 1%		CC CENTER CABLE	72"	C CUSTOM	4' X 4'
Q1 - OL	CP CUSTOM PROGRAMMED (Specify Lumens/FT or Watts/FT)	4K 4000K		(120/277) 1% DIM		SM SURFACE			OTHER (SPECIFY)

LUMENS & LED COLOR OPTIONS

	SQ SIZE	WATTS	2700K	3000K	3500K	4000K
LOW LUMENS	2' SQ	28W	4000 L	4240 L	4280 L	4480 L
	3' SQ	42W	6000 L	6360 L	6420 L	6720 L
	4' SQ	56W	8000 L	8480 L	8560 L	8960 L
MEDIUM LUMENS	2' SQ	52W	6960 L	7320 L	7360 L	7760 L
	3' SQ	78W	10440 L	10980 L	11040 L	11640 L
	4' SQ	104W	13920 L	14640 L	14720 L	15520 L
HIGH LUMENS	2' SQ	72W	9280 L	9760 L	9800 L	10320 L
	3' SQ	108W	13920 L	14640 L	14700 L	15480 L
	4' SQ	144W	18560 L	19520 L	19600 L	20640 L

Higher lumen packages available.

LENS OPTIONS

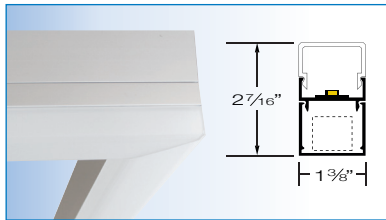

SQL – SQUARE LENS

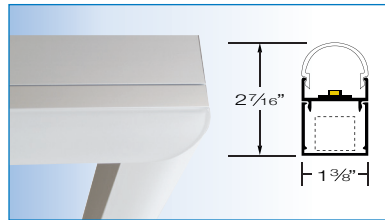

RLR – ROUND LENS

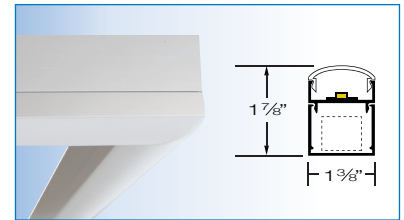

FRL – FLAT ROUND LENS

REMOTE LED DRIVERS WITH ENCLOSURE *(Included)*

Universal Voltage (120/277) 0–10V Dimming

Remote LED drivers recommended for easy maintenance.



WATTS

1 – 50W

2 – 50W

1 – 85W

2 – 85W

ENCLOSURE DIMENSIONS

16" X 2" x 1 1/4"

28" X 2" x 1 1/4" (ENCLOSURE W/ TWO DRIVERS)

18" X 2" x 1 1/4"

34" X 2" x 1 1/4" (ENCLOSURE W/ TWO DRIVERS)

20' Max Remote Driver Distance

The chart below shows watts / fixture and driver requirements.

Some medium and high lumen fixtures require more than one driver; Refer to chart below.

SQUARE SIZE	LOW LUMENS		MEDIUM LUMENS		HIGH LUMENS	
	WATTS	DRIVERS REQUIRED	WATTS	DRIVERS REQUIRED	WATTS	DRIVERS REQUIRED
2' X 2'	31W	1 - 50W	63W	1 - 85W	92W	2 - 50W
3' X 3'	47W	1 - 50W	95W	2 - 50W	138W	2 - 85W
4' X 4'	62W	1 - 85W	126W	2 - 85W	184W	4 - 50W

MOUNTING OPTIONS

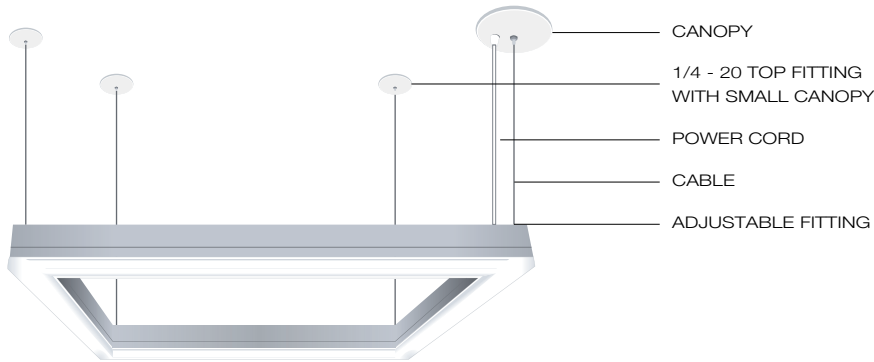

SC - STRAIGHT CABLES STYLE

- Suspension Kit includes:
- (1) 5" Round Canopy with Mounting Hardware
 - (4) Top Fittings for 1/4-20 Rod with Small Canopy
 - (1 or 2) Prewired 18/2 or 18/5 White Power Cord
 - (4) Aircraft Cables 36", 48" or 72"
 - (4) Adjustable Bottom Fittings

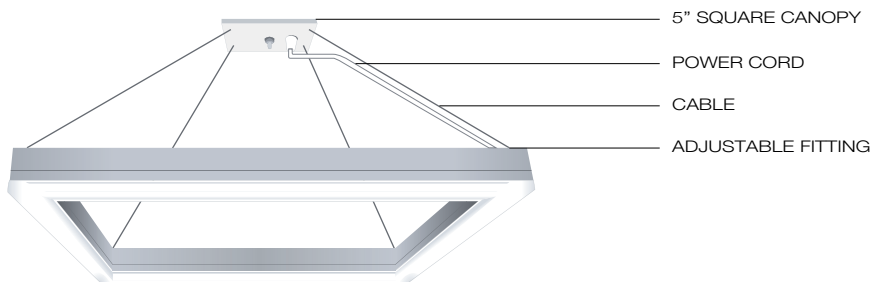

PC - PYRAMID CABLES STYLE

- Suspension Kit includes:
- (1) 5" Square Canopy with Mounting Hardware
 - (1 or 2) Prewired 18/2 or 18/5 White Power Cord
 - (4) Aircraft Cables 36", 48" or 72"
 - (4) Adjustable Bottom Fittings

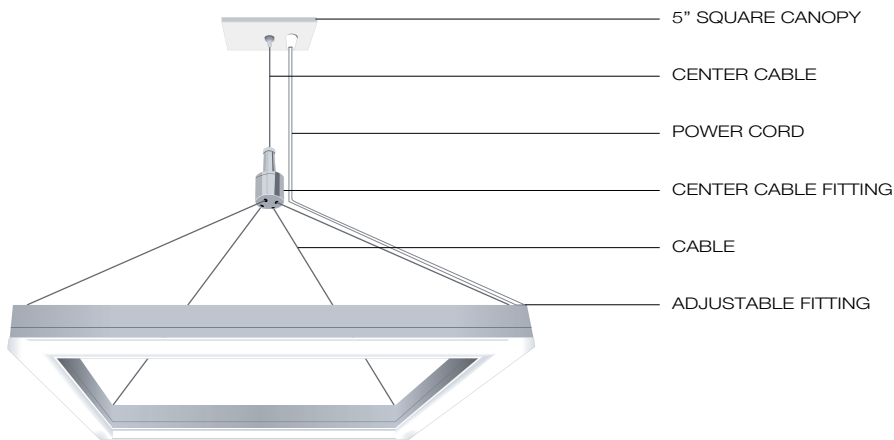

CC - CENTER CABLE STYLE

- Suspension Kit includes:
- (1) 5" Square Canopy with Mounting Hardware
 - (1) Center Aircraft Cable
 - (1 or 2) Prewired 18/2 or 18/5 White Power Cord
 - (1) Center Cable Fitting
 - (4) Aircraft Cables 36", 48" or 72"
 - (4) Adjustable Bottom Fittings

* Note: Fixture can rotate due to the flow of air in a given area.

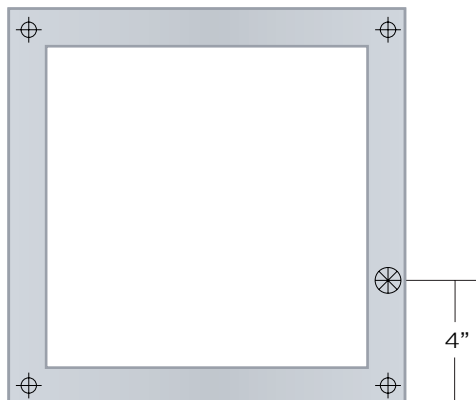

SM - SURFACE MOUNT

- ⊕ 1/4" Mounting Holes Provided
- ⊗ 1/2" Service Hole Provided for Snap in Connector

* Position of mounting holes may vary; Consult Factory

FIXTURE SIZES

	2' SQUARE		3' SQUARE		4' SQUARE	
	NOMINAL SIZE	ACTUAL SIZE	NOMINAL SIZE	ACTUAL SIZE	NOMINAL SIZE	ACTUAL SIZE
DOWN LIGHT	2' X 2'	24" X 24"	3' X 3'	35" X 35"	4' X 4'	46" X 46"
UP LIGHT	2' X 2'	24" X 24"	3' X 3'	35" X 35"	4' X 4'	46" X 46"
INWARD LIGHT	2' X 2'	26" X 26"	3' X 3'	37" X 37"	4' X 4'	48" X 48"
OUTWARD LIGHT	2' X 2'	* 24.5" X 24.5"	3' X 3'	* 35.5" X 35.5"	4' X 4'	* 46.5" X 46.5"

* Outside dimension is 7/8" less with FRL lens. Other sizes and rectangles available; Consult Factory

PHOTOMETRICS / CANDELA DISTRIBUTION

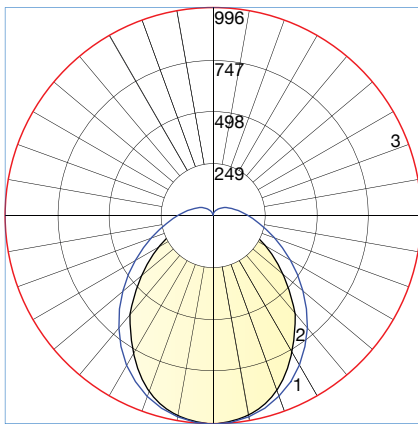

SQL – SQUARE LENS

POLAR GRAPH

FILE NAME: L011501402.IES

Maximum Candela = 432 (Low Lumens)

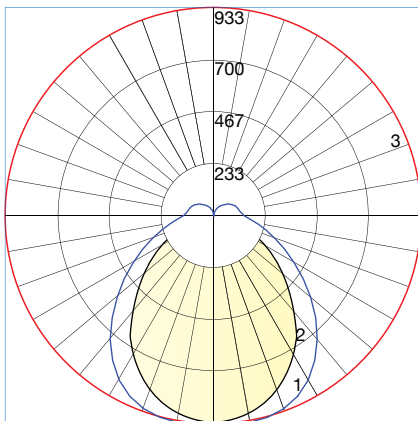

RLR – ROUND LENS

POLAR GRAPH

FILE NAME: L011501401.IES

Maximum Candela = 432 (Low Lumens)

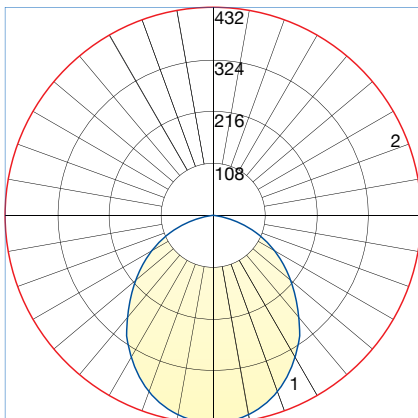

FRL – FLAT ROUND LENS

POLAR GRAPH

FILE NAME: L10137801R01.IES

Maximum Candela = 432 (Low Lumens)