

MARQUEE (ALX)

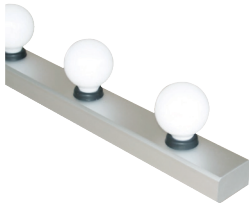
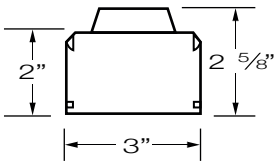

MQ3-MB (ALX3-MB)

MEDIUM BASE WET / DAMP

MQ3-CB (ALX3-CB)

CANDELABRA BASE DAMP ONLY

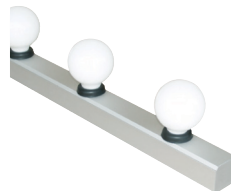
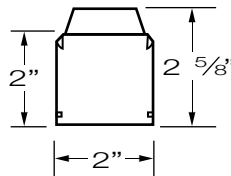

MQ2-MB (ALX2-MB)

MEDIUM BASE WET / DAMP

MQ2-CB (ALX2-CB)

CANDELABRA BASE DAMP ONLY

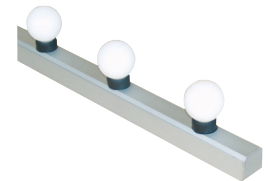
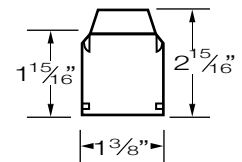

MQ1-CB (ALX1-CB)

CANDELABRA BASE DAMP ONLY

See Next Page For Installation Important Information



CAREFULLY REVIEW THE FOLLOWING INFORMATION AND INSTALLATION STEPS TO ENSURE THE PRODUCT IS INSTALLED SAFELY AND CORRECTLY.

INSTALLATION MUST BE PERFORMED BY A LICENSED CONTRACTOR OR QUALIFIED ELECTRICIAN FAMILIAR WITH APPLICABLE CODES AND SAFETY STANDARDS. IMPROPER INSTALLATION CAN RESULT IN SERIOUS INJURY OR DEATH.

FAILURE TO FOLLOW THESE INSTRUCTIONS AND AS A RESULT OF INCORRECT INSTALLATION WILL VOID PRODUCT WARRANTY

MANUFACTURER ASSUMES NO LIABILITY FOR PRODUCT OR PROPERTY DAMAGE OR INJURY RESULTING FROM FAILURE TO FOLLOW THESE INSTRUCTIONS, MISUSE OF THE PRODUCT, OR INSTALLATION NOT PERFORMED IN ACCORDANCE WITH LOCAL BUILDING AND ELECTRICAL CODES

NEC AND LOCAL CODE AWARENESS

Installation must be done in accordance with (NEC) National Electrical Code and any other local code requirements

SAFETY WARNINGS

Do not install this product on or nearby flammable materials

Do not install this product in hazardous locations

Caution, to reduce the risk of fire use 125V, 60W max. MB (Medium Base) or CB (Candelabra Base) lamps.

1920 watts is the maximum load per circuit per (NEC) code, do not exceed.

Example: 32 lamps 60W ea. = 1920W total (this is the maximum per circuit)

GENERAL NOTES

Contact manufacture with any questions Ph: 661-495-5700 or info@primuslighting.com

INDEX

PAGE

Marquee Series -----	1
Important Information -----	2
Installation Steps-----	3

See Next Page For Installation Steps

MARQUEE (MQ) SERIES

INSTALLATION GUIDE
SURFACE MOUNT



End View

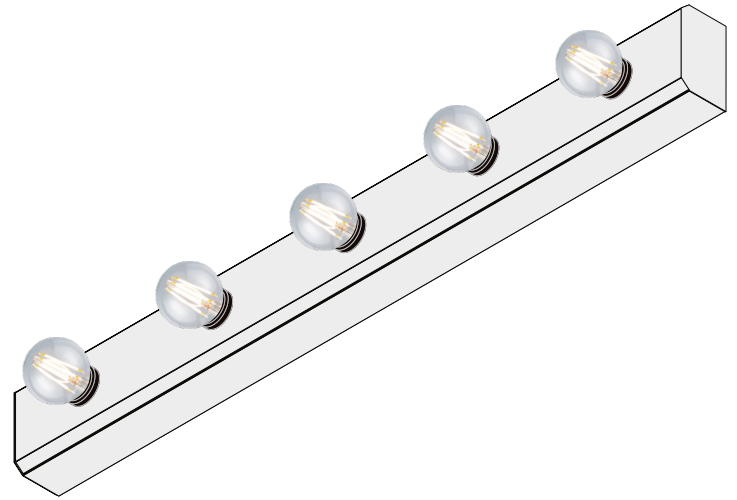
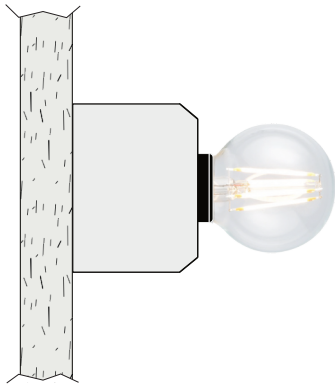

Installation Steps

- 1 Remove the socket cover assembly from bottom channel.

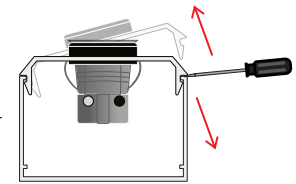

- 2 Secure the bottom channel to mounting surface by using the mounting holes provided inside the channel. (screws by others)

- 3 To prevent the accumulation of water, drill a 1/8" drain hole at the lowest point of the channel.

- 4 Make power connections using the pre-ordered K/O on endcaps or pre-ordered power service hole or your field drill service hole (All electrical hardware by others)

- 5 Close fixture, snap in the socket cover assembly to the bottom channel.

- 6 Install the lamps and make sure the waterproof gasket is attached to the socket if applicable. (For wet location only)

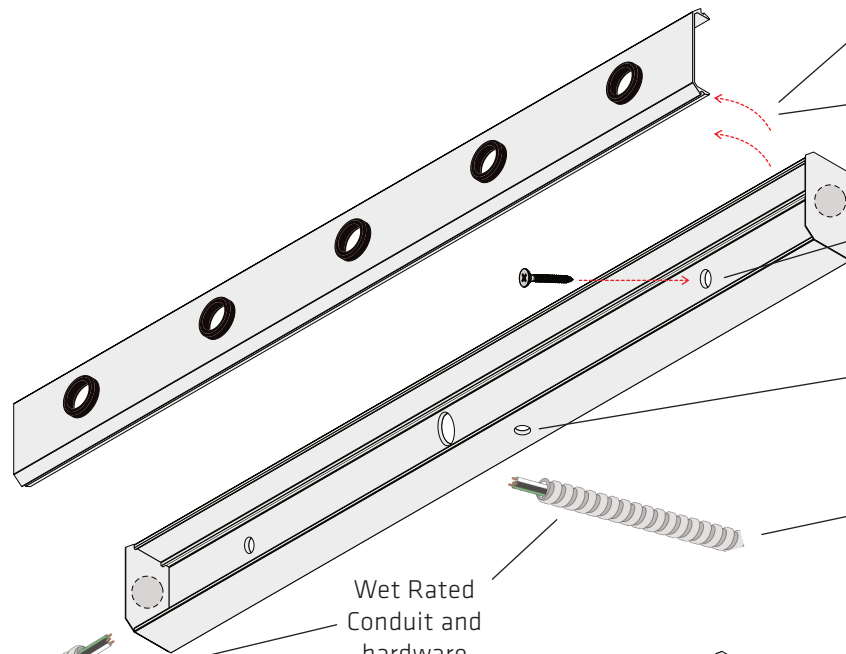

Wet Rated Conduit and hardware (By others)

