

COVE 5 (CV5) SERIES

HIGH PERFORMANCE COVE / INDIRECT LIGHTING



PROJECT

TYPE

NOTES

FEATURES

CONSTRUCTION

High quality precision extruded aluminum that has a superior strength-to-weight ratio than steel allowing for longer runs and a premium finish and wide spread acrylic lens for broad even light distribution.

ASYMMETRIC LIGHT DISTRIBUTION

A carefully designed asymmetric light distribution, focusing light in one direction while providing smoother illumination compared to symmetric light distributions.

VERSATILE SOLUTION

The CV5 is a highly versatile lighting solution, perfectly suited for a wide range of applications. Whether it's wall washing, wall grazing, or serving as a wall sconce, the CV5 delivers. Its adaptability extends to both regular and inverted cove lighting solutions, making it an ideal choice for various architectural and design scenarios due to the consistent and reliable illumination tailored to specific needs.

CUSTOMIZATION

The wider housing enables easy integration of various new LED types, colors, drivers, finishes, configurations, and mounting options, allowing you to fully customize your fixture to meet specific needs.

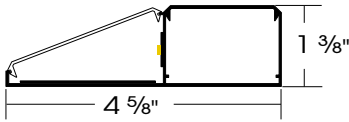

CV5-FL

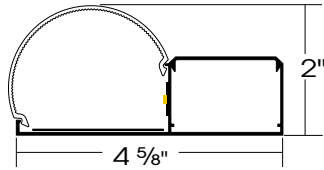

CV5-RL

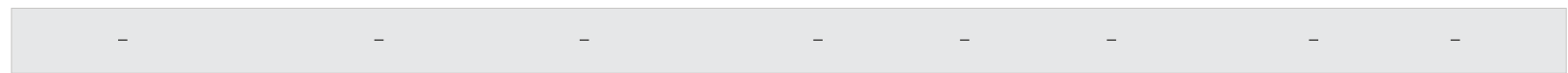

| SERIES | LED TYPE | LUMENS | REMOTE DRIVER | OPTIONS | ENDCAPS | MOUNTING | FINISH | LENGTH |
|-----------------|---------------------|-------------------------|-------------------------|----------------------|-----------------|------------------------|-------------------------|---------------|
| CV5-FL | STANDARD LED | FOR STANDARD LED | FOR STANDARD LED | EM PACKS | STANDARD | SURFACE MOUNT | | 2' |
| | 27K 2700k | L LOW | UNV0% 0-10V0% | EM1 | BEK | SMF | W WHITE | 3' |
| CV5-RL | 30K 3000k | M MEDIUM | UNV1% 0-10V1% | 800 LUMENS | BOTH END K/O | SMW | S SATIN | 4' |
| | 35K 3500k | H HIGH | UNV10% 0-10V10% | EM2 | OEK | SMV | B BLACK | 5' |
| | 40K 4000k | CL CUSTOM LUMENS | UNVCD% 0-10VCD | 1400 LUMENS | ONE END K/O | JBP | C CUSTOM | 6' |
| | SPECIAL LED | FOR SPECIAL LED | FOR SPECIAL LED | SENSORS | BE | CABLE SUSPENDED | A ANTI MICROBIAL | 7' |
| | R RED | Specify | Refer to driver | MSP | BLANK ENDS | CSHD(48 or 72) | | 8' |
| | G GREEN | required | options in | BI-LEVEL | FD | CSHU(48 or 72) | | 9' |
| | B BLUE | lumens | compatibility chart | SENSOR | FIELD DRILL | CSV(48 or72) | | 10' |
| | RGBW RGBW | or | or | ARCHITECTURAL | | | | 11' |
| | DTW DIM TO WARM | consult factory | consult factory | ABE | BLANK ENDS | | | 12' |
| | TW TUNABLE WHITE | | | | | | | OTHER SPECIFY |
| Refer to PG.1,2 | Refer to PG. 3 | Refer to PG. 3 | Refer to PG. 3 | Refer to PG. 4 | Refer to PG. 4 | Refer to PG. 5 -6 | Refer to PG. 7 | PTN |



COVE 5 (CV5) SERIES

SERIES - SPECIFICATIONS



SERIES

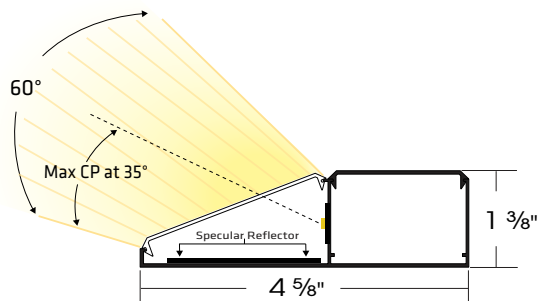

CV5-FL
COVE 5 FLAT LENS

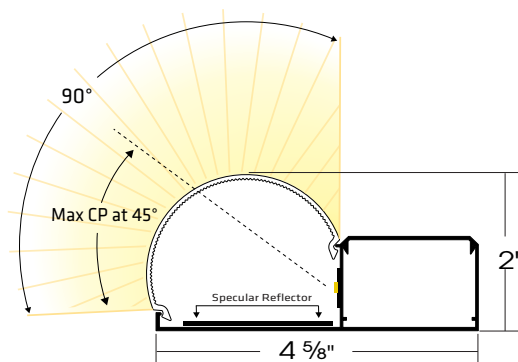

CV5-RL
COVE 5 ROUNDED LENS

SPECIFICATIONS

HOUSING

High quality extruded aluminum snap together housing up to 12' long. Continuous longer runs can be made in the field by connecting multiple fixtures using our internal joiners.

REFLECTORS

High specular reflector installed inside the fixture to improve light performance.

LENS

Extruded flat and rounded snap on DR acrylic with white frosted finish for widespread and even light distribution.

LED'S

Standard LED'S 60,000 hours. (L70), High uniformity 90CRI, 2700K TO 4000K, refer to page 3 for lumen details and options.

Special LED'S red, green, blue, RGBW, Dim to warm, Tunable white, refer to page 3 for details and options.

LED DRIVERS

Integral, universal voltage (120/277), 0-10V with custom program dimming options, Triac, Dali, Lutron, refer to page 3 for details and options.

OPTIONS

EM Packs and **Sensors**, refer to page 4 details and options. Consult factory for other options requirements not show.

ENDCAPS

Aluminum, pre-installed, **Standard** or **Architectural** endcaps that match housing finish, refer to page 4 for details and options.

MOUNTING

Surface Mount and **Cable Suspended**, refer to page 5 for details and options.

FINISH

Powder coat and Satin anodized. White, satin and black are standard finishes, refer to page 7 for more details, custom colors and antimicrobial finish options.

FIXTURE LENGTHS

Refer to page 7 for standard and custom lengths and patterns options

COMPLIANCE CERTIFICATIONS



COVE 5 (CV5) SERIES

LED TYPES-DRIVERS-COMPATIBILITY



LED TYPES

| STANDARD LED'S | | | DESCRIPTION | | | | | | | | |
|----------------|-------|--------|----------------|----------|---------|-------------------|----------|---------|-----------------|----------|---------|
| COLOR | | CRI | (L) LOW LUMENS | | | (M) MEDIUM LUMENS | | | (H) HIGH LUMENS | | |
| 27k | 2700K | CRI 90 | 584 L/FT | 3.5 W/FT | 163 L/W | 1038 L/FT | 6.5 W/FT | 158 L/W | 1390 L/FT | 9.0 W/FT | 154 L/W |
| 30k | 3000K | CRI 90 | 604 L/FT | 3.5 W/FT | 169 L/W | 1075 L/FT | 6.5 W/FT | 163 L/W | 1439 L/FT | 9.0 W/FT | 159 L/W |
| 35k | 3500K | CRI 90 | 625 L/FT | 3.5 W/FT | 175 L/W | 1111 L/FT | 6.5 W/FT | 169 L/W | 1488 L/FT | 9.0 W/FT | 164 L/W |
| 40k | 4000K | CRI 90 | 645 L/FT | 3.5 W/FT | 181 L/W | 1148 L/FT | 6.5 W/FT | 174 L/W | 1537 L/FT | 9.0 W/FT | 170 L/W |

(CL) Custom Lumens. Custom and higher lumen available. Other colors and higher Kelvin also available, consult factory.

| SPECIAL LED'S | DESCRIPTION | | LUMENS |
|---------------|---------------|------------------|--|
| R | RED | Static Red LED | Specify Required Lumens or Consult factory |
| G | GREEN | Static Green LED | |
| B | BLUE | Static Blue LED | |
| RGBW | RGBW | Color Tuning | |
| DTW | DIM TO WARM | 4000k - 1800K | |
| TW | TUNABLE WHITE | 2700k - 6500k | |

Specify or consult factory for any other type of LED requirements not shown above such as led type, LED color, lumens, etc.

LED DRIVERS (Integral)

| DRIVER | DESCRIPTION | | | |
|-----------------|------------------------|----------------------------------|----------|--------------------|
| UNV0% | 0 - 10V Dimming Driver | 0% Dimming (Dim to Off) | 120/277V | (347V Available) |
| UNV1% | 0 - 10V Dimming Driver | 1% Dimming | 120/277V | (347V Available) |
| UNV10% | 0 - 10V Dimming Driver | 10% Dimming | 120/277V | (347V Available) |
| UNV(CD)% | 0 - 10V Dimming Driver | Custom Dimming (Specify %) | 120/277V | (347V Available) |
| TRIAC | 2 Wire Dimming Driver | 2 Wire Phase Triac Dimming | 120/277V | |
| DALI | Dali Dimming Driver | Dali, Specify Dali Type Required | 120/277V | (347V Available) |
| LTRN | Lutron Dimming Driver | Lutron, Specify Type Required | 120/277V | |

Specify or consult factory for any other type of LED DRIVER requirements not shown above.

LED TYPES & DRIVERS COMPATIBILITY

| STANDARD LED'S | DRIVER | | | | | | |
|----------------------|--------|-------|--------|----------|-------|------|--------|
| 27k | UNV0% | UNV1% | UNV10% | UNV(CD)% | TRIAC | DALI | LUTRON |
| 30k | UNV0% | UNV1% | UNV10% | UNV(CD)% | TRIAC | DALI | LUTRON |
| 35k | UNV0% | UNV1% | UNV10% | UNV(CD)% | TRIAC | DALI | LUTRON |
| 40k | UNV0% | UNV1% | UNV10% | UNV(CD)% | TRIAC | DALI | LUTRON |
| SPECIAL LED'S | | | | | | | |
| R | UNV0% | UNV1% | UNV10% | UNV(CD)% | TRIAC | DALI | LUTRON |
| G | UNV0% | UNV1% | UNV10% | UNV(CD)% | TRIAC | DALI | LUTRON |
| B | UNV0% | UNV1% | UNV10% | UNV(CD)% | TRIAC | DALI | LUTRON |
| RGBW | | | | | | DALI | LUTRON |
| DTW | UNV0% | UNV1% | UNV10% | UNV(CD)% | | DALI | LUTRON |
| TW | UNV0% | UNV1% | UNV10% | UNV(CD)% | | DALI | LUTRON |

Specify or consult factory for any other type of LED DRIVER requirements not shown above.

COVE 5 (CV5) SERIES

EM PACKS - SENSORS - ENDCAPS



EM PACKS

EM PACKS are pre-installed inside the fixture with test-switch also included and pre-installed. Depending on the application, the test switch / charger indicator will be installed on top or side of the fixture. Specify or consult factory for other type of emergency lighting requirements.

| PART NO. | LUMENS | OPERATION TIME |
|----------|-------------|----------------|
| EM1 | 800 LUMENS | 90 MINUTES |
| EM2 | 1400 LUMENS | 90 MINUTES |



SENSORS

Bi-level motion sensors are pre-installed and need to be programmed in the field, programming instructions are included. Not recommended for cove lighting or any other obstructed areas that doesn't allow the sensor to operate properly. Specify or consult factory for other type of sensors requirements.

| PART NO. | DESCRIPTION |
|----------|------------------------|
| MSP | BI-LEVEL MOTION SENSOR |



ENDCAPS

Aluminum construction and pre-installed
Two style endcaps, standard with or with out K/O's and architectural plain endcaps.
Endcap matches housing finish.



STANDARD ENDCAPS

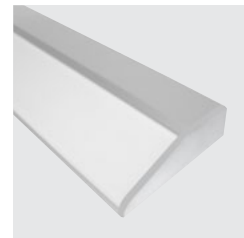

ARCHITECTURAL ENDCAPS

| PART NO. | DESCRIPTION |
|----------|--------------------------|
| BEK | BOTH ENDS K/O |
| OEK | ONE END K/O |
| BE | BLANK ENDCAPS |
| FD | FIELD DRILL (BLANK ENDS) |

| PART NO. | DESCRIPTION |
|----------|---|
| ABE | 3/16" PLATE BLANK ENDCAPS (Back center or field drill k/o on fixture for surface mount) |

COVE 5 (CV5) SERIES

MOUNTING OPTIONS



SURFACE MOUNT

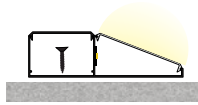

SMF
SURFACE MOUNT FLAT
(up or down light)

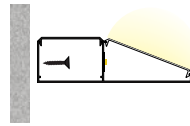

SMW
SURFACE MOUNT WALL
(up or down light)
(Not ADA at 28-80" height from floor)

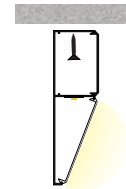

SMV
SURFACE MOUNT VERTICAL

MOUNTING DETAILS



¼" MOUNTING HOLES C/L
½" BACK CENTER SERVICE HOLE

- ¼" Mounting holes provided evenly spaced on back channel.
- ½" Back center service hole for snap-in connector provided for surface mount applications when using standard blank or architectural endcap
- (FD) Field drilled optional..
- 2' fixtures require off center service hole due to 12" driver

Note: Narrow side of housing will not cover recessed J Box, whip feed recommended. Use optional "JBP" canopy plate for J-Box mount. (See picture above)

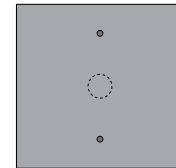

J BOX PLATE

| PART NO. | DESCRIPTION |
|----------|---|
| JBP | 5" Flat canopy plate to cover J-Box (Optional) (JBP matches fixture finish) |

PENDANT MOUNT

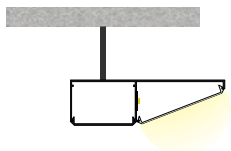

CSHD (48 or 72")
CABLE SUSPENDED
HORIZONTAL DOWN LIGHT

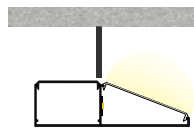

CSHU (48 or 72")
CABLE SUSPENDED
HORIZONTAL UP LIGHT

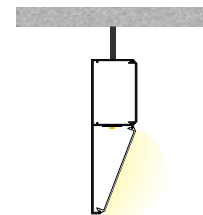

CSV(48 or 72")
CABLE SUSPENDED VERTICAL

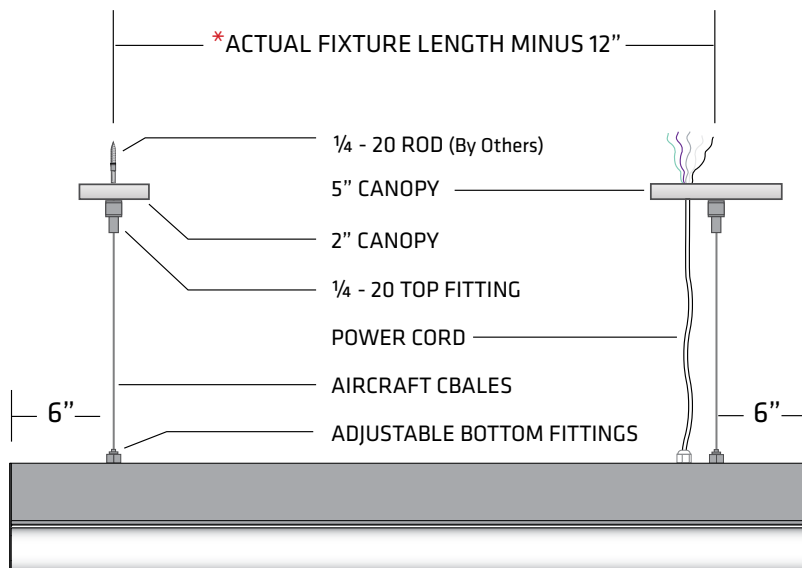

CABLE SUSPENSION KIT 48" AND 72"

EACH SUSPENSION KIT INCLUDES:

- (1) 5" White canopy with mounting hardware
- (1) 2" White canopy
- (2) Top fittings for ¼-20 Rod
- (1) Power cord pre-wired to fixture 18/5 white SVT
- (2) Aircraft cables 48" or 72", (other lengths available)
- (2) Adjustable bottom fittings pre-attached to fixture

- * Canopies white finish standard, consult factory for other finishes
- * Custom pendant spacing available, specify or consult factory
- * Lengths over 8' require center cable support
- * EM options include 18/6 power cord

COVE 5 (CV5) SERIES

FINISH - FIXTURE LENGTHS



FINISH OPTIONS

Powder coat and sating anodized.

White, satin and black are standard finishes.

Custom colors and antimicrobial white finish also available.

White or satin finishes are recommended for cove and indirect lighting applications.

The actual color of the product may vary from what is seen on electronic devices.

We cannot guarantee that the color you see on your screen accurately reflects the true color of the product.



W - WHITE

(Powder Coat, Standard)



S - SATIN

(Clear Anodized, Standard)

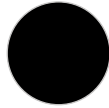

B - BLACK

(Powder Coat, Standard)

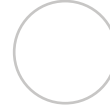

A - ANTI MICROBIAL

(Powder Coat White
Consult Factory)



C - CUSTOM COLOR

(Not standard, [provide RAL#](#))

FIXTURE LENGTHS

Refer to the chart below for standard lengths.

Lengths can be ordered in shorter or longer lengths than the ones specified below.

12' Long is the maximum length in one single & continuous channel, longer lengths are made by connecting end to end multiple fixtures.

Custom patterns, and custom runs configuration require a drawing or template.

For cove lighting specify the overall length of your cove and we will determine the number and length of fixtures for the overall length required.

| NOMINAL LENGTH | 2' | 3' | 4' | 5' | 6' | 7' | 8' | 9' | 10' | 11' | 12' | OTHER SPECIFY | PTN Pattern |
|----------------|-----|-----|-----|-----|-----|-----|-----|------|------|------|------|------------------|----------------|
| ACTUAL LENGTH | 25" | 34" | 49" | 56" | 73" | 89" | 97" | 111" | 121" | 133" | 145" | | |

PATTERNS

Whipped corners are the optimal solution and offer installation "wobble room" making exact tolerances less critical. For closed coffers we need at least 4 of the following 5 measurements for best results. Mitered corners are possible but require exact measurements.

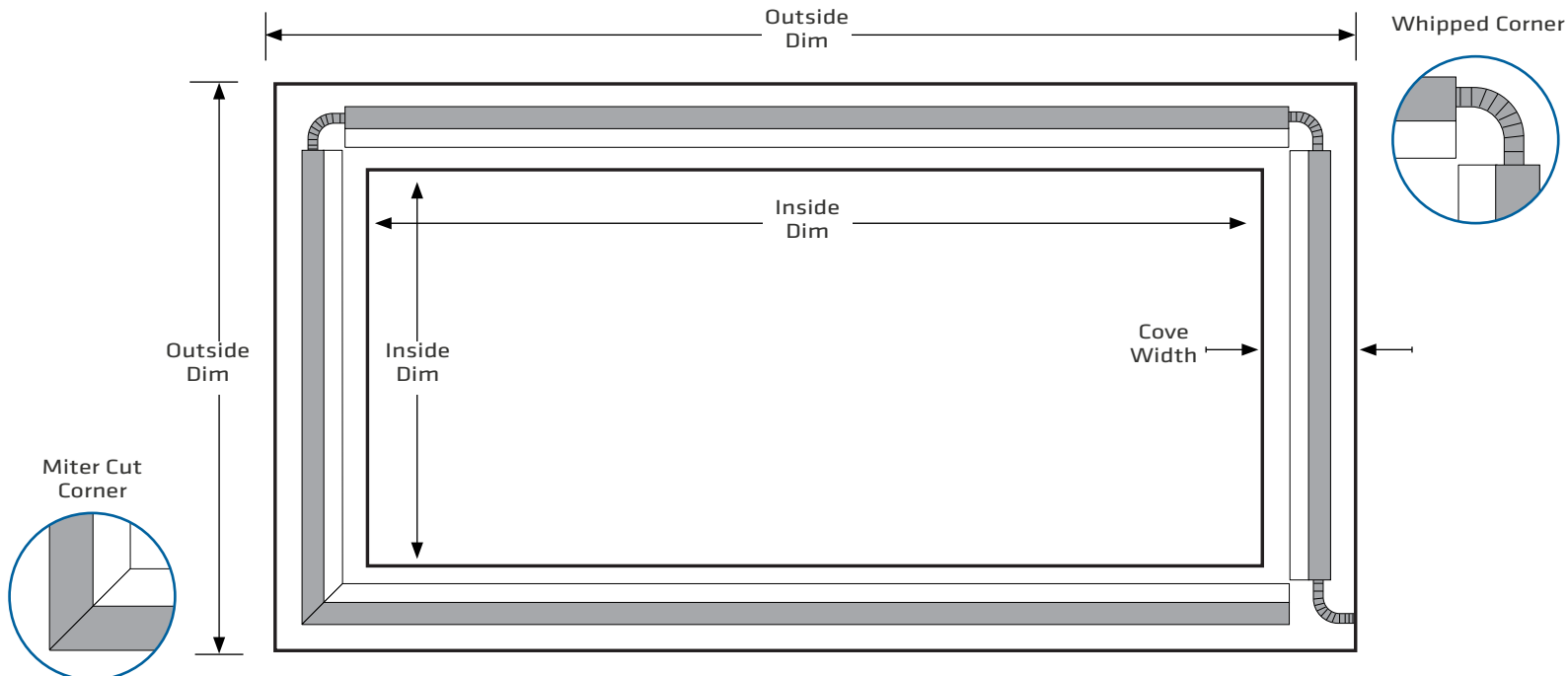

COVE 5 (CV5) SERIES

LIGHTING GUIDE AND PHOTOMETRICS

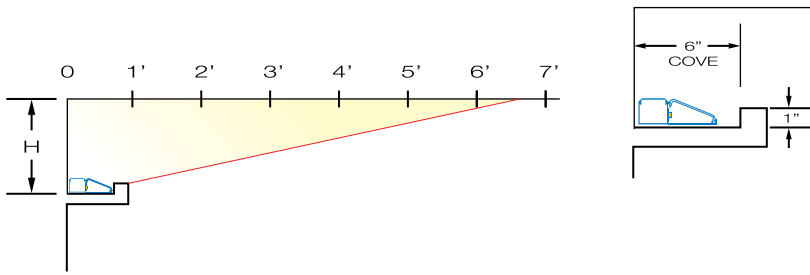

CEILING COVE FOOTCANDLES

| H | 1' | 2' | 3' | 4' | 5' | 6' | 7' | 8' |
|-----|----|----|----|----|----|----|----|----|
| 12" | 20 | 18 | 16 | 14 | 12 | 10 | 6 | 3 |
| 18" | 18 | 16 | 14 | 12 | 10 | 6 | 5 | 3 |
| 24" | 14 | 12 | 10 | 9 | 8 | 7 | 6 | 5 |
| 36" | 12 | 10 | 9 | 8 | 7 | 6 | 5 | 2 |
| 48" | 9 | 8 | 7 | 6 | 5 | 4 | 3 | 1 |

Calculation using "low lumen" 400 lumen/ft 3500K LED'S.

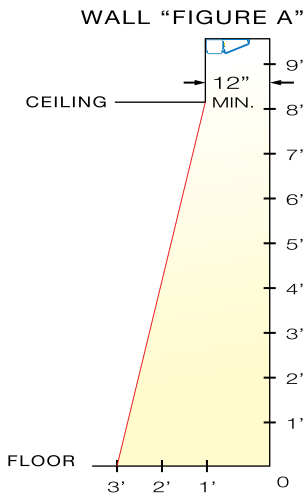

"FIGURE A" WALL WASH FOOTCANDLES

| | 8' | 7' | 6' | 5' | 4' | 3' | 2' | 1' |
|-------|----|----|----|----|----|----|----|----|
| WALL | 93 | 46 | 23 | 13 | 9 | 6 | 5 | 4 |
| FLOOR | | | 7 | 9 | 10 | 11 | 13 | 14 |

Calculation using "low lumen" 400 lumen/ft 3500K LED'S.

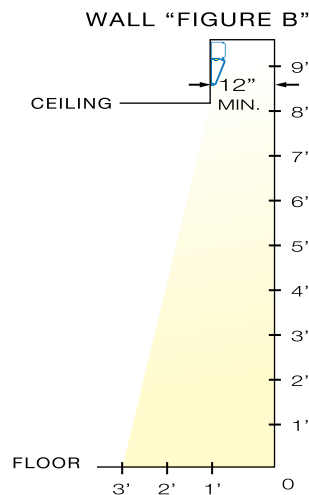

"FIGURE B" WALL WASH FOOTCANDLES

| | 9' | 8' | 7' | 6' | 5' | 4' | 3' | 2' | 1' |
|-------|-----|----|----|----|----|----|----|----|----|
| WALL | 123 | 46 | 20 | 11 | 7 | 5 | 4 | 3 | 2 |
| FLOOR | | | | 4 | 5 | 5 | 5 | 4 | 14 |

Calculation using "low lumen" 400 lumen/ft 3500K LED'S.

CABLE SUSPENDED
WALL (SEE COVE FOOTCANDLES)
FLOOR (SEE FIGURE B FOOTCANDLES)

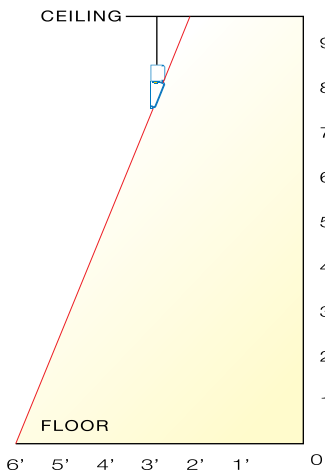

PHOTOMETRICS

FILE NAME: L10137802R01.IES

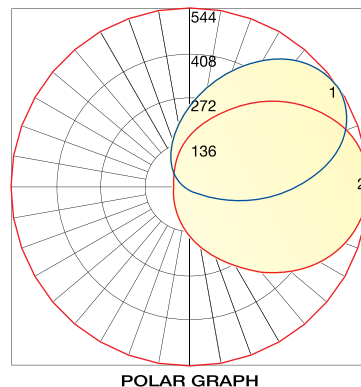

Maximum Candela = 544

Located at Horizontal Angle = 0 Vertical Angle = 125

#1 - Vertical Plane through Horizontal Angles (0-180) (Through Max. Cd.)

#2 - Horizontal Cone through Vertical Angle (125) (Through Max. Cd.)

SPECIFICATIONS ARE SUBJECT TO CHANGE DUE TO CONTINUOUS ADVANCES IN TECHNOLOGY
© PRIMUS LIGHTING, INC. ALL RIGHTS RESERVED